

dormakaba digital cylinder

Technical Manual

1220013692 - 04/2019

EN

dormakaba 

dormakaba Schweiz AG
Mühlebühlstrasse 23
8620 Wetzikon
Switzerland
T: +41 (0)44 931 61 11

www.dormakaba.com

dormakaba Austria GmbH
Ulrich-Bremi-Straße 2
3130 Herzogenburg
Austria
T: +43 (0)2782 808 0

www.dormakaba.com

Copyright © dormakaba 2019
All rights reserved.

No part of this document may be reproduced or used in any form or by any means without prior written permission of dormakaba Schweiz AG.

All names and logos of third-party products and services are the property of their respective owners.

Subject to technical changes.

Table of contents

1	Regarding this document	5
1.1	Validity	5
1.2	Target group	5
1.3	Contents and purpose	6
1.4	Document availability	6
1.5	Additional documents	6
1.6	Abbreviations/definition of terms	6
1.7	Hazard categories	7
1.8	Notes	7
1.9	Symbols	7
2	Basic safety instructions	8
2.1	Proper use	8
2.2	Product changes	8
2.3	Use in emergency exit or panic door locks	8
2.4	Areas of use	9
2.5	ESD protective measures	10
2.6	Handling of lithium batteries	10
3	Product description	11
3.1	Overview	11
3.1.1	Structure	11
3.2	Scope of delivery	11
3.2.1	Also for dual digital cylinder	11
3.3	Accessories	11
3.4	Technical data	13
3.4.1	Dimensions	14
3.5	Conformity	17
3.6	System requirements	17
4	Installation	18
4.1	Notes	18
4.2	Requirements	18
4.2.1	Door components	18
4.2.2	Tools required	19
4.3	Installation versions	20
4.3.1	Installation version A	21
4.3.2	Installation version B	23
4.3.3	Function check on anti-panic digital cylinder	26
5	Program/configure a component	27
5.1	Define media technology	27
5.2	Methods for programming and configuration	27
5.3	Programming with system software and programmer	27
5.4	Master media	28
5.5	User media	28
5.6	Program structures	29
5.6.1	A/B structure	29
5.6.2	B structure	29
5.7	Programming with media	30
5.7.1	Define highest Master medium	30
5.7.2	Create A/B structure	31
5.7.3	Grant access permissions	32
5.7.4	Revoke individual access permissions	33
5.7.5	Delete Master Bs from the component	34

5.7.6	Revoke all access permission assigned by Master B	35
5.7.7	INI reset with Master media	35
5.8	Initialising the device for Mobile Access	35
5.9	Set Bluetooth signal strength	36
5.10	Initializing the device for evolo smart	36
6	Operation	37
6.1	Operating the digital cylinder	37
6.2	Opening with user media	37
6.3	Opening via smartphone	38
7	Maintenance	40
7.1	Maintenance table	40
7.2	Maintenance of escape doors	40
7.3	Cleaning	41
8	Service	42
8.1	Replacing the battery	42
8.2	Disassembling the inner door knob	44
8.2.1	Thumbturn «click»	44
8.2.2	Thumbturn «small»	44
8.3	Configuration and traceback	44
8.4	Reset (INI reset)	45
8.4.1	INI reset with Master media	45
8.4.2	Reset using programmer 1460	46
8.4.3	Reset using tweezers	46
8.4.4	Contacts for INI reset	47
8.5	Emergency power supply	47
8.6	Connect programmer.	47
9	Troubleshooting	48
9.1	Error analysis	48
9.2	Error analysis for battery life	50
10	Appendix	51
10.1	Summary of various factors influencing the battery operation	51
10.2	Recommendations for battery operation	51

1 Regarding this document

This section contains information about properly using this document.

Notes



This document is part of the product and is to be submitted to the customer after installation.



The instructions described in this document as well as the manuals on installation, commissioning, operation, maintenance and servicing of the product absolutely must be observed.

1.1 Validity

This document describes the product:

Product designation:	dormakaba Digital cylinder
Types:	143X dormakaba Digital cylinder with Euro profile (17 mm) 153X dormakaba Digital cylinder with round profile (22 mm)
Device generation:	From K5 (MRD), K6
Article numbers and variants:	
Euro profile cylinder	1435 Standard 1434 Half 1437 Anti-panic 1439 Dual 1431 Asymmetrical 1433 Half with turning range
Round profile cylinder	1535 Standard 1534 Half 1537 Anti-panic 1539 Dual 1531 Asymmetrical 1533 Half with turning range
Versions:	With the exception of the asymmetrical version, all components are available as 'protected' variants (with high anti-drill protection).
Device generation K6 onwards	All variants are available with wireless functionality. All variants are prepared for Bluetooth® and are available for Mobile Access.
Mobile Access option:	
Firmware	version 42.28 or higher

1.2 Target group

This documentation is oriented toward all trained personnel.

Skilled person is the designation for people who have the appropriate technical training and experience in setting up the equipment. Skilled persons are expected to use their training and experience to identify any risks to themselves and others that may arise while carrying out these activities, and to minimise these risks as far as possible. It is the skilled person's responsibility to ensure that the conditions stated by the manufacturer and the applicable regulations and standards are complied with when carrying out these actions.

1.3 Contents and purpose

The contents of these instructions are limited to the installation, operation, maintenance and servicing of the product.

1.4 Document availability

Additional documentation is available on the dormakaba website. The manuals can be found in a protected area (extranet). They can be accessed using the user account of trained specialists or a temporary user account.

<https://www.dormakaba.com/extranet-emea-en/login>

1.5 Additional documents



The following documents are available from the sales partners and in the extranet:

- evolo system description
- Programmer 1460 technical manual
- Documentation for the system software used
- Wireless planning guideline
- Mobile Access planning guidelines

1.6 Abbreviations/definition of terms

Short name	Product designation
Digital cylinder	dormakaba Digital cylinder
Product	dormakaba Digital cylinder
Device	dormakaba Digital cylinder
Programmer	Programmer 1460
Bluetooth	Bluetooth®

Symbols

Symbols	
	Acoustic signal
	Visual signal

1.7 Hazard categories

Instructions with information on what to do and not to do to prevent injury and material damage are denoted specially.

Please follow all hazard instructions. These are intended to help prevent accidents and prevent damage.

These instructions are divided into the following categories:



DANGER

High risk

Denotes an immediate danger that could lead to serious injury or death.



WARNING

Medium risk

Denotes a potentially dangerous situation that could lead to serious injury or death.



CAUTION

Low risk

Denotes a potentially dangerous situation that could lead to minor injury.



NOTICE

Important information on the correct use of the product.

Failure to comply with these instructions could lead to malfunctions. The product and/or objects in the local vicinity could be damaged.

1.8 Notes

Information is denoted by this symbol.



Tips on using the product are useful pieces of information. They help to make best use of the product and its functions.

1.9 Symbols

Symbols with the following meanings are used for hazards (depending on hazard source.)



General hazard



Hazard from electric shock



Risk of explosion



Risk to electronic components from electrostatic discharge

2 Basic safety instructions

This product has been built to state-of-the-art standards and in line with established safety regulations. However, hazards for persons and property may arise when handling the product.



Read and observe the following safety instructions before using the product.

2.1 Proper use

This product has been designed exclusively for use as set out in the chapter Product Description. Any other use will be deemed improper use. The manufacturer accepts no liability for any resulting damage. The user/operator bears sole responsibility for the risk.

2.2 Product changes



NOTICE

No changes should be made to the product, unless in accordance with changes described in the instructions.

2.3 Use in emergency exit or panic door locks



⚠ WARNING

Risk of personal injury or death.

- Improper use or incorrectly installed digital cylinders can lead to emergency exit locks or panic door locks and doors not opening.
- The use of a digital cylinder must be checked carefully before using it in locks with a panic function.
- Before installing the digital cylinder in an escape door, a check must be carried out to ensure that the function of the lever handle or the panic push bar is not obstructed by the inside knob.
- The use of a digital cylinder in emergency exit locks in accordance with EN 179 or in panic door locks in accordance with EN 1125 is documented in the lock manufacturers' performance declarations. If the digital cylinder is not listed in the performance declarations or certificates from the lock manufacturer or the lock does not comply with these standards, an EC conformity inspection of the lock, digital cylinder, fitting and assembly accessories as one unit must be carried out.

2.4 Areas of use

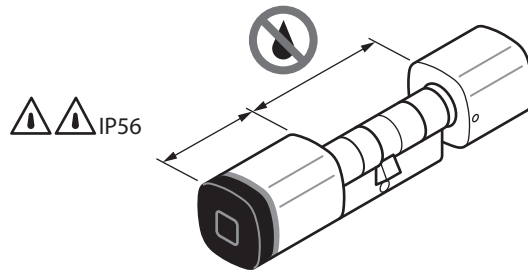

When used outdoors, the cylinder must be protected against sustained rainfall using a weather guard.



NOTICE

Freezing liquids can disrupt the function, resulting in doors not opening. No water, therefore, should get into the cylinder. When used externally, the cylinder must be protected against sustained rainfall using a weather guard.

When used in fire protection doors, escape routes or rescue routes, the locally applicable guidelines and building regulations must be observed.



NOTICE

Doors at risk of forced entry

- The following points must be observed for certification as per VdS Class B: On doors at risk of forced entry, the 'Protected' version of the digital cylinder must be protected with a VdS-recognised burglary-resistant Class B or C doorplate. These doorplates correspond to DIN 18 257 Class ES 2 or ES 3 and EN1906 Class 3 or 4. The cylinder must protrude no more than 3 mm beyond the doorplate.
- The user media (keys, badges, etc.) must always be kept safe to ensure only authorised personnel may gain access. If identification media are lost, the authorisation data must be blocked and deleted from all cylinders immediately.



NOTICE

Wrong type of lock

The asymmetrical digital cylinder is not permitted to be used in some lock types. Please refer to the lock manufacturer's instructions.

2.5 ESD protective measures



NOTICE

Danger of damage to electronic components from electrostatic discharge.

If electronic printed circuit boards and components are handled incorrectly, damage may occur which leads to their complete breakdown or sporadic faults.

- When installing and repairing the product, the general ESD protective measures are to be observed.
 - Before starting service or maintenance work on the product, e.g. changing the battery, briefly touch the door handle. This will safely and effectively conduct charges away from your body.
 - When handling electronic components, wear the ESD wrist strap. Connect the end of the strap to an ESD socket or an unpainted, earthed metal component. This will safely and effectively conduct charges away from your body.
 - Only handle the edges of printed circuit boards. Do not touch printed circuit boards or connecting plugs.
 - Put removed components on an anti-static surface or in an anti-static shielding container.
 - Avoid contact between printed circuit boards and clothing. The wrist strap only protects the printed circuit boards from static electricity on the body. Damage can still occur due to static electricity on clothing.
 - Only transport and ship removed modules in ESD-shielding, conductive protective containers.
-

2.6 Handling of lithium batteries



NOTICE

Lithium batteries can explode or burst explosively.

Improper handling of lithium batteries can lead to fires and explosions.

- Only replace lithium batteries with batteries of the same type.
 - Do not open, drill through or squash lithium batteries.
 - Do not burn lithium batteries or expose them to high temperatures.
 - Do not short circuit lithium batteries.
 - Do not recharge lithium batteries.
-

3 Product description

This section provides an overview of the product and gives information on technical details.

3.1 Overview

The digital cylinder is an electronic locking cylinder with a reader antenna on the rotary knob. Depending on the version, the reader antenna may be on the outer knob or on both the outer and inner knob. The security-related electronics are installed behind the anti-drill protection in the rotor. After identification using authorised media, the lock and door can be opened manually. An acoustic and optical signal denotes access authorisation.

3.1.1 Structure

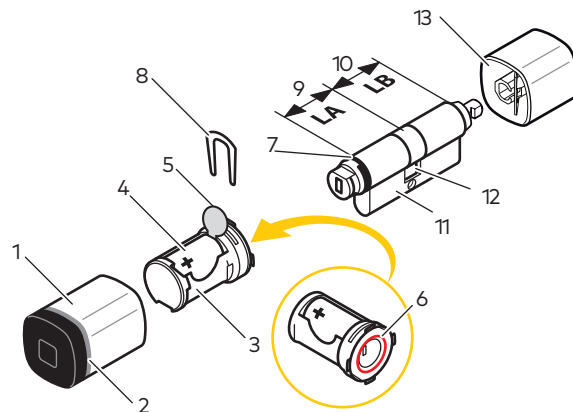

- | | | | |
|---|-------------------------------|----|--------------------------|
| 1 | Outer knob | 8 | Securing shackle |
| 2 | Cover with light ring | 9 | LA, length on outer side |
| 3 | Door knob module with antenna | 10 | LB, length on inner side |
| 4 | Battery | 11 | Cylinder housing |
| 5 | Contact protection film | 12 | Cam |
| 6 | O-ring, Ø 15 x 1 mm | 13 | Thumbturn |
| 7 | MC insert | | |

3.2 Scope of delivery

- 1 digital cylinder
- 1 forend locking stud
- 1 battery, CR2 lithium type
- 1 set of instructions

3.2.1 Also for dual digital cylinder

- 1 battery, CR2 lithium type

3.3 Accessories

- Relevant system software and programming tools

For Mobile Access applications:

Mobile Access	
APP	Description
DOOR by dormakaba	Smartphone app for opening the doors.
VCP installer	Smartphone app for putting door components into operation (evolo components, access reader).
evolo smart	Smartphone app for online management and putting door components into operation without using any system software.

The apps for iOS or Android can be downloaded via Apple iTunes or Google Play.

3.4 Technical data

The digital cylinder is intended for use in building doors that are equipped with a lock.

Technical data		
Dimensions		
Outer knob	Ø x L	36 x 45 mm
Inner knob	Ø x L	36 x 29 mm
Small inner knob	Ø x L	30 x 27 mm
Dual inner knob	Ø x L	36 x 45 mm
Backset	35 mm	Door opening inwards (all variants)
	30 mm	Door opening outwards (default inner knob)
	35 mm	Door opening outwards (dual inner knob)
	25 mm	Door opening outwards (small inner knob)
Power supply		
Battery	3 V, CR2 lithium	
Radio interface		
Technology	IEEE 802.15.4	
Frequency band	2,400 to 2,485.5 MHz	
Transmitting power	+8 dBm	
Receiver sensitivity	-102 dBm @ 1% PER	
Media technology		
RFID	LEGIC	advant/prime
	MIFARE	DESFire/classic
Mobile Access	Bluetooth and NFC	
Ambient conditions		
Protection type	IP56	Outer knob (default)
Temperature	-25 °C – +70 °C	The temperature range depends on the battery manufacturer's specifications.
Humidity	0%–95% rH, non-condensing	
Climate	Not suitable for heavily corrosive atmospheres (chlorine, ammonia).	
Rooms	Not to be used in potentially explosive environments.	
Standards		
VdS	'Protected' version: class BZ+	
Classification according to EN 15684	Place:	1 2 3 4 5 6 7 8
	Classification:	1 6 B 4 A F 3 2
Resistance to fire	EN 1634-2: 95 min	Variants 1439 and 1539 from total length 85 mm

Technical data		
Durability	> 200,000 cycles EN 1303 class 6 EN 179/EN 1125 class 7	
Corrosion	DIN EN 1670 class 3 DIN EN ISO 6988, severity level 3 (SO ₂ test)	
Dimensions	DIN 18252	Profile cylinder
	SN-EN 1303	Round profile cylinder
Cycles		
Battery life at 20 °C	Approx. 50,000 cycles	Dependent on the configuration used. The specifications refer to the operation mode whitelist.
Battery life at -20 °C	EXT version: approx. 40,000 cycles	

3.4.1 Dimensions



The dimensions stated also apply for the 22 mm round profile cylinder.

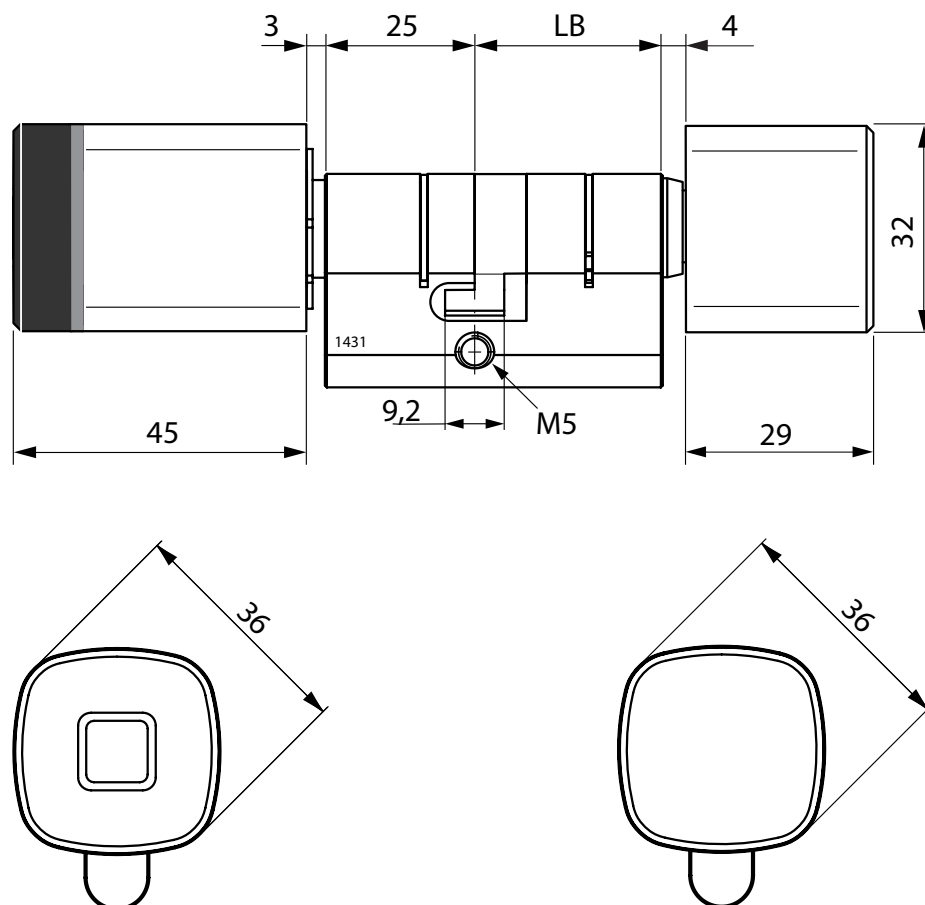

Dimension drawing 1431 Asymmetrical (profile cylinder)

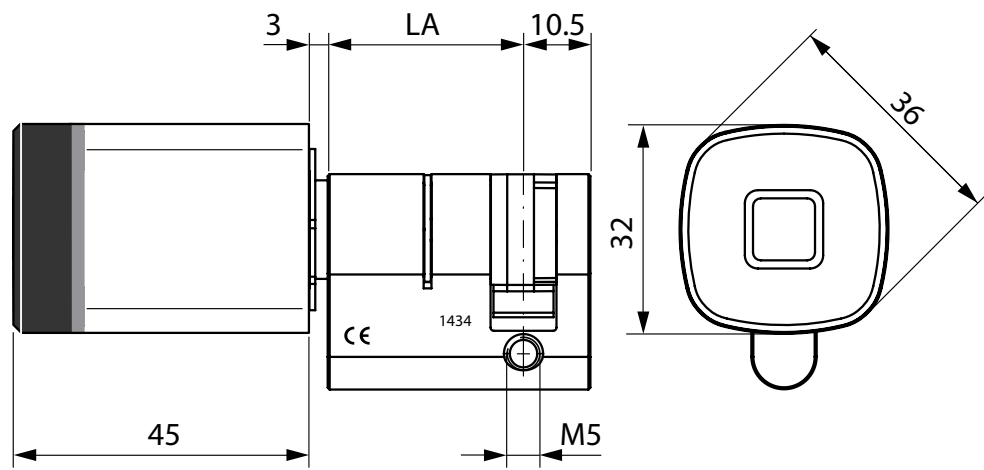

Dimension drawing 1434 Half with outer knob profile (profile cylinder)

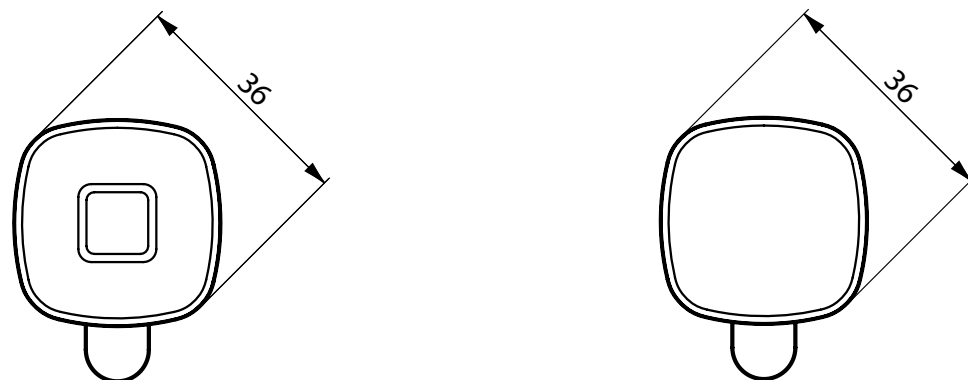
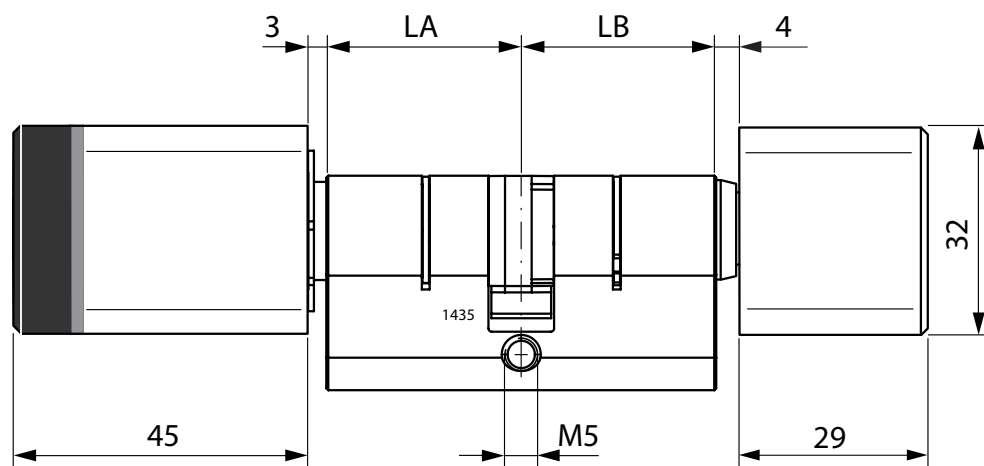

Dimension drawing 1435 Standard (profile cylinder)

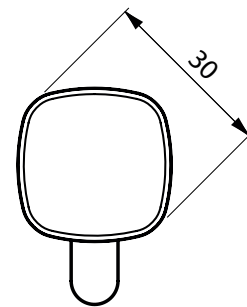
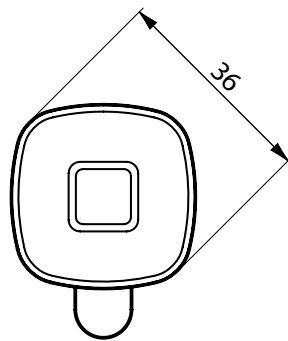
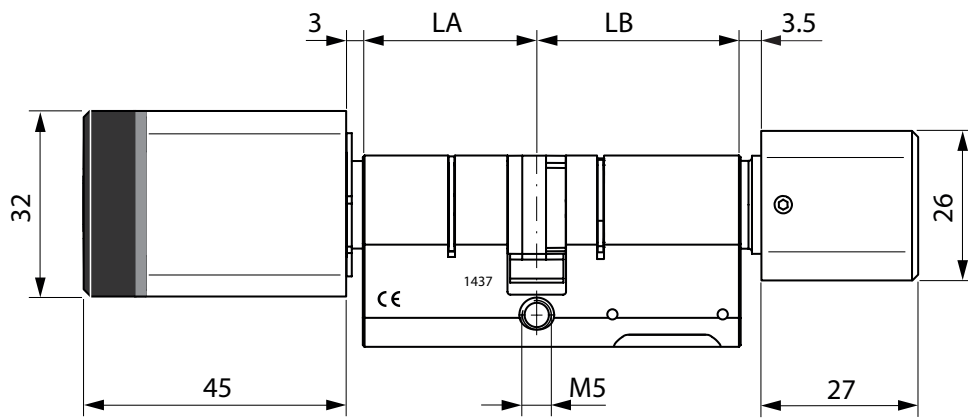

Dimension drawing 1437 Anti-panic, small inner knob version (profile cylinder)

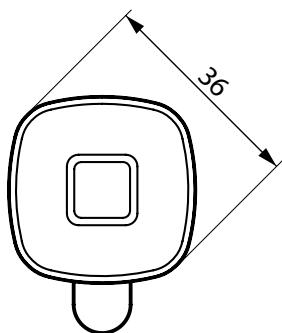
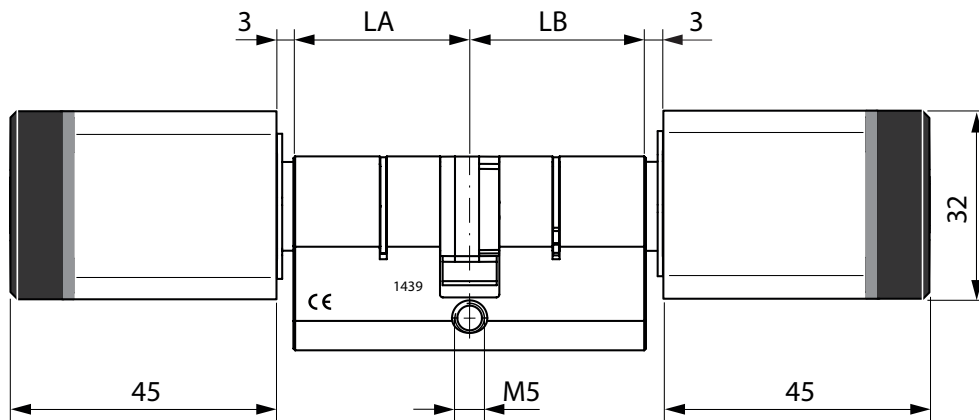

Dimension drawing 1439 Dual (profile cylinder)

3.5 Conformity



This product conforms to the EU directives
 2014/53/EU Radio Equipment Directive
 2011/65/EU RoHS Directive



You can download the original declaration of conformity in PDF format at www.dormakaba.com/conformity.

3.6 System requirements

Firmware/System software

Function	Firmware	System software	
		Kaba exos	MATRIX
Mobile Access	See section Validity > Mobile Access option	version 4.0.73 or higher	MATRIX Professional version 3.2.x or higher; with Mobile Access option

4 Installation

This chapter describes the installation of the product.

4.1 Notes



The instructions described in this document as well as the manuals on installation, commissioning, operation, maintenance and servicing of the product absolutely must be observed.



All components of the product must be installed.



The parts attached to the door must not impact the function of the Digital cylinder.



The fire protection-related assessment/check was completed according to EN 1634-2 on a double-leaf metal revolving door. The test record is available on the dormakaba site in a protected area (Extranet). See under "Document availability".

4.2 Requirements

4.2.1 Door components

Locking cylinder

The locking cylinder with Euro profile or round profile can be used in any door made from wood, glass or metal, in accordance with the cylinder perforations.

A notch is required for the locking cylinder with the **anti-panic round profile cylinder** as this has a pin going all the way through on the inside (LB).

The locking cylinder with the **Euro profile cylinder and dual round profile cylinder**, in the protected version (VdS class BZ+) only offers high anti-drill protection on the outside (LA).



WARNING

Risk of personal injury or death.

- Improper use or incorrectly installed digital cylinders can lead to emergency exit locks or panic door locks and doors not opening.
- The use of a digital cylinder must be checked carefully before using it in locks with a panic function.
- Before installing the digital cylinder in an escape door, a check must be carried out to ensure that the function of the lever handle or the panic push bar is not obstructed by the inside knob.
- The use of a digital cylinder in emergency exit locks in accordance with EN 179 or in panic door locks in accordance with EN 1125 is documented in the lock manufacturers' performance declarations. If the digital cylinder is not listed in the performance declarations or certificates from the lock manufacturer or the lock does not comply with these standards, an EC conformity inspection of the lock, digital cylinder, fitting and assembly accessories as one unit must be carried out.



NOTICE

Danger of damage to electronic components from electrostatic discharge.

Improper handling can damage or destroy electrostatically sensitive circuit board components.

- Observe and apply general ESD safety measures.

Check the dimensions

The following dimensions are to be checked prior to installation:

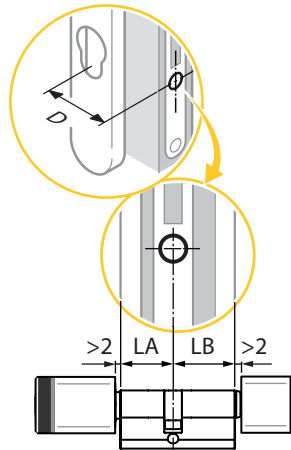

1. Check the door thickness with the fittings (LA and LB) and the cylinder length.
2. Check the profile cut-out and the backset (D).



- In order for the multitool to be inserted between the knob and the plate, choose cylinder lengths so as to retain at least a 2 mm gap between the plate and the knob.
- In accordance with DIN 18257 for security hardware and security plates, in doors with security hardware (burglary-resistant fitting) the cylinder housing should not protrude more than 3 mm from the external plate.
- Determine the length of the forend screw: Forend screw \geq backset + 10 mm.

4.2.2 Tools required

- Tool – Multitool
- Allen key, small inner knob, 2 mm hex
- Flat head and Phillips screwdriver
- Programming cable
- Adaptor/programming pin

4.3 Installation versions



NOTICE

When installing the lock, there is a risk of being locking out.

Always install the digital cylinder when the door is open. This prevents you from locking yourself out when using self-locking locks.



The locking cylinder in the digital cylinder version without an inner knob and the dual version should be programmed before carrying out the function test. After this, hold an authorised user medium in front of the cylinder and carry out the function test by turning the outer door knob.

With **installation variant A**, remove the inner knob and push the cylinder through the fitting and the lock from the outer side of the door.

With **installation variant B**, remove the outer knob and also the inner door knob if necessary, and push the cylinder through the door's lock.

Digital cylinder installation variants

Type	Installation variants	
	A	B
1431 Asymmetrical 1435 Standard	recommended	optional
1433 Half with turning range 1434 Half	—	optional
1437 Anti-panic	recommended	optional
1439 Dual	—	recommended
1531 Asymmetrical 1535 Standard	not recommended	recommended
1533 Half with turning range 1534 Half	—	optional
1537 Anti-panic ¹	not recommended	optional
1539 Dual	—	recommended

Legend:

¹ The fitting needs a recess on the inner side for the cylinder pin.

4.3.1 Installation version A

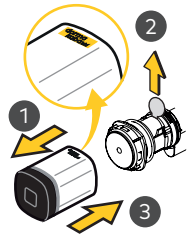

1. Remove the outer knob.
2. Remove the contact protection film.
3. Attach the outer knob.

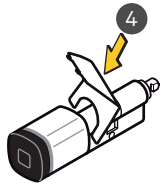

4. Position the multitool on the outer knob.

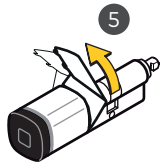

5. Turn the multitool to the left and lock it. The outer knob and the cylinder housing are now firmly connected.

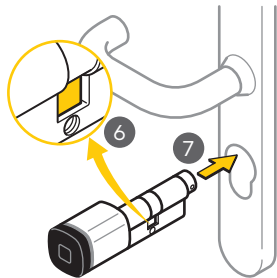

6. Align the cam flush with the cylinder housing.
7. From the outer side of the door, push the Digital cylinder through the fitting and the lock.

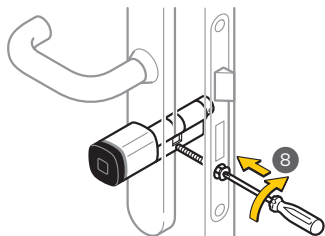

8. Position the forend locking stud in the lock and tighten it slightly.

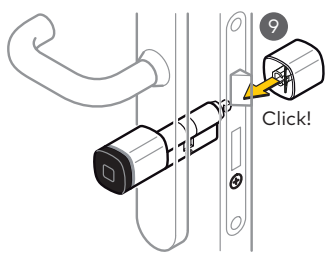

9. Thumbturn: Align the locking spring and the notch with each other!

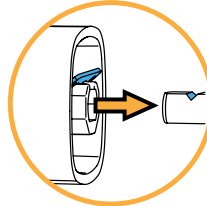

Place the thumbturn on the cylinder housing.
Thumbturn "small":

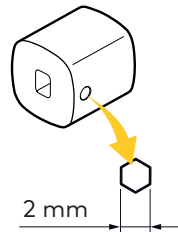

Tighten the grub screw.

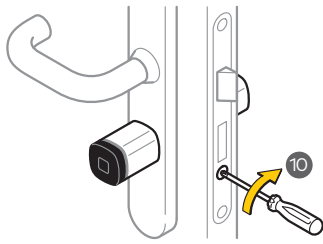

10. Tighten the forend locking stud.

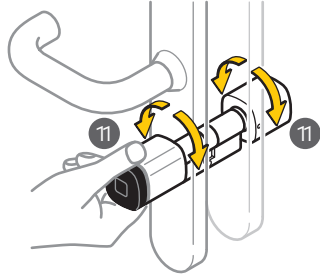

11. Check that the door knobs function correctly.
Both door knobs can be turned without touching the fittings.

12. Check the backset.
The door knobs must not knock against the door frame.

4.3.2 Installation version B

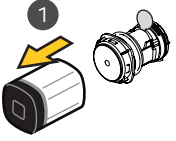
- 

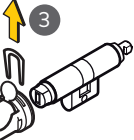
1. Remove the outer knob.
- 

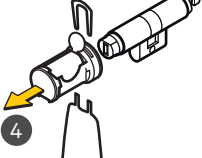
2. Attach the multitool to the securing shackle from below.
- 

3. Pull out the securing shackle.
- 

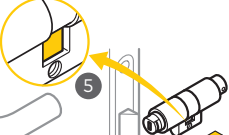
4. Remove the knob module.
- 

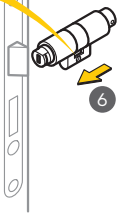
5. Align the cam flush with the cylinder housing.
- 

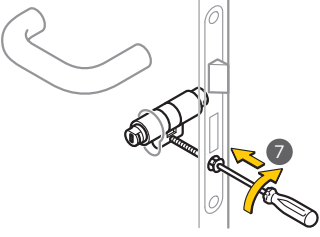
6. Push the cylinder housing through the lock from the inner side of the door.
- 

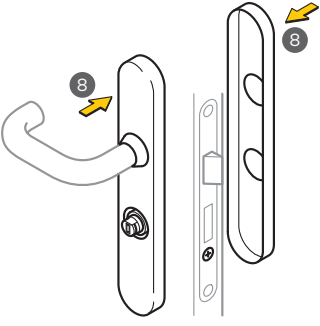
7. Position the forend locking stud in the lock and tighten it slightly.
- 

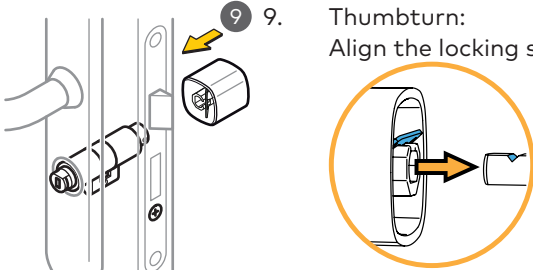
8. Install the fittings.
- 

9. Thumbturn:
Align the locking spring and the notch with each other!

Place the thumbturn on the cylinder housing.

Thumbturn "small":

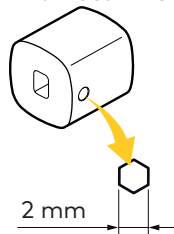

Tighten the grub screw.

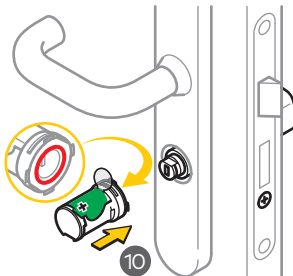

10. Put the knob module on to the cylinder housing.

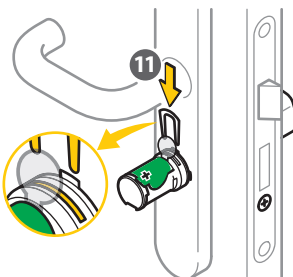

11. Push the securing shackle into the knob module from above until it stops.
The knob module and cylinder housing are now firmly connected.

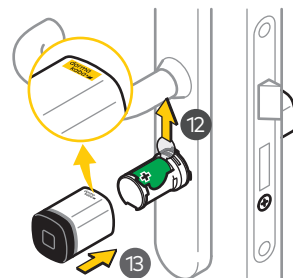

12. Remove the contact protection film.

13. **Note:**
Be careful not to tilt the edge of the knob when installing.

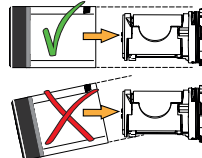

Push the outer knob over the knob module.

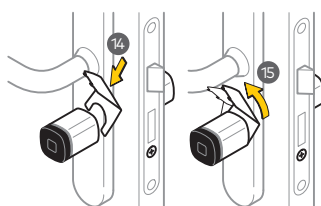

14. Position the multitool on the outer knob.

15. Turn the multitool to the left and lock it.
The outer knob and the cylinder housing are now firmly connected.

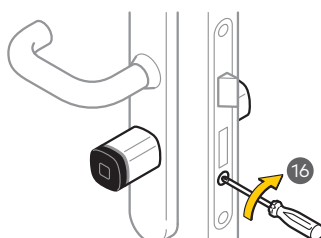

16. Tighten the forend locking stud.

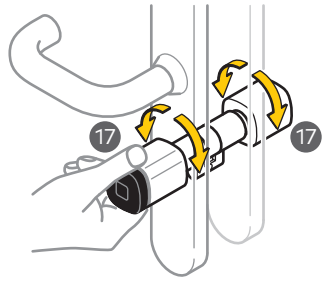

17. Check that the door knobs function correctly. Both door knobs can be turned without touching the fittings.

18. Check the backset.
The door knobs must not knock against the door frame.

4.3.3 Function check on anti-panic digital cylinder

After installing an anti-panic digital cylinder, a function check must be carried out.



⚠ WARNING

Risk of personal injury or death.

- After installing the digital cylinder in a panic lock, a function check must be carried out. It must be possible to open the lock with the lever handle in all cam rest areas.
- For emergency exit or panic door locks, it is vital that the specifications of the lock and fittings manufacturers are observed.

A spring mechanism in the locking cylinder ensures that the cam cannot be positioned in an area that is not authorised for panic locks.



a) upper authorised rest area



b) lower authorised rest area

Check the reset function as shown:



Check that the lock functions correctly

1. Turn the inner door knob upwards until it cannot be reset. (Rest area pointing up at 12 o'clock).
Note: If there is no inner door knob, use the outer door knob.

2. Press the handle. The lock should unlock.

3. Turn the inner knob downwards until it cannot be reset. (Rest area pointing down at 6 o'clock.)

4. Press the handle. The lock should unlock.



Check that the locking cylinder is functioning correctly

1. Turn the inner door knob to the 11 o'clock position and release it. The inner door knob should turn back automatically.

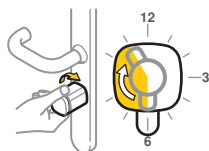

2. Turn the inner door knob to the 1 o'clock position and release it. The inner door knob should turn back automatically.

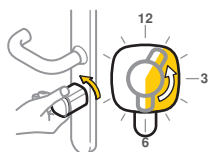

5 Program/configure a component

The media technology must be defined before programming. See section Define media technology [\[► 5.1\]](#).

Access permissions and other permissions are assigned through subsequent programming/configuration of the components.

5.1 Define media technology

Upon first use, multi RFID (MRD) components are defined using a master LEGIC or MIFARE for the technology for which the components are to be operated. After that, the components act as defined for the authorisation types LEGIC (LEA) or MIFARE (MID).

Procedure

- Hold the master medium up to the antenna for approx. 1 second.
 - The media technology of the master medium (Legic or MIFARE) has been transmitted to the device.

Note: After an INI reset, the technology must be redefined.

5.2 Methods for programming and configuration

Methods:

- With system software and programmer,
See section Programming with system software and programmer [\[► 5.3\]](#)
- With master and user media,
See section Programming with media [\[► 5.7\]](#)
- Wireless applications:
Commissioning with system software and programmer,
after which configuration takes place via wireless gateway.
See programmer manual, wireless gateway manual and system description.
- Mobile Access devices: After transmitting the configuration using the programmer: Initial-
ise the device for Mobile Access,
See section Initialising the device for Mobile Access [\[► 5.8\]](#)
- evolo smart:
The app guides the user through the procedure.

5.3 Programming with system software and programmer

Procedure

- Configure the device in the system software.
- Transmit the configuration to the programmer.
- Hold the master medium up to the antenna for approx. 1 second.
- Connect the programmer to the device.
- Transmit the configuration from the programmer to the device.

See also:

- System description
- Documentation for the system software used
- Programmer 1460 technical manual
- Planning guidelines for wireless

5.4 Master media

The components are programmed with Master A media and Master B media. Master Bs are organised under a Master A. The Master media have no access permissions.



5.5 User media

All user media are organised under a Master B.



NOTICE

Unauthorised access with lost medium

Remove lost medium from components:

- Revoke all access permissions with the Master (remove from the whitelist), see section "Revoke all access permissions assigned by Master B."
 - Grant the still-valid user permissions (add to whitelist), see section "Grant access permissions."
 - Repeat the process on all components to which the lost medium has access.
-

5.6 Program structures

Organisation of the components in an A/B structure or a B structure.

5.6.1 A/B structure

Master A

Master B

User media

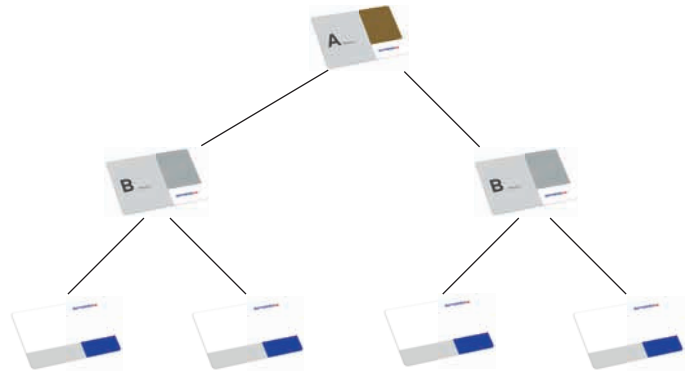

Master A:

- Create at most 200 Master Bs
- No programming of user media
- No programming of access permissions
- For additional applications, see the following section

Master B:

- Assignment and revocation of access permissions

User media:

- At most 4,000 user media
- The distribution of the users to different Master Bs is arbitrary

Example of 1 component of a system

- Master B1: 50 users
- Master B2: 3,950 users

Total = 4,000: Maximum number of users has been reached.

5.6.2 B structure

Master B

User media

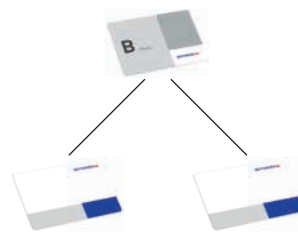

Master B:

- Assignment and revocation of access permissions
- For additional applications, see the following section

User media:

- At most 4,000 user media
- Distribution of the users to multiple Master Bs is **not** possible.

5.7 Programming with media



Holding up a Master medium (approx. 1 s) activates programming mode.

Leaving programming mode:

Automatic, 20 s after the last medium was held up (timeout) or by holding up the Master medium again (approx. 1 s).

5.7.1 Define highest Master medium

- The highest Master medium is the highest medium of a component.
- Each component must be assigned 1 highest Master medium.
- Each component can only be assigned 1 highest Master medium.
- The first Master medium that is held up to a component will be registered as the highest Master medium.

A/B structure

- In an A/B structure, the highest Master medium must be a Master A.
- A Master A can grant permissions to Master Bs. See section "Create A/B structure."
- A Master A can revoke permissions from Master Bs. See section "Delete Master Bs from the component"
- An INI reset can be initiated with a Master A, see section "INI reset with Master media"

B structure

- In a B structure, the highest Master medium must be a Master B.
- An INI reset can be initiated with a Master B, see section "INI reset with Master media"

Prerequisites

- The component has factory settings assigned, see INI reset.

Procedure

	<p>Hold Master medium (A or B) up to the antenna for approx. 1 second.</p> <ul style="list-style-type: none"> -> Glows green. -> 1 short signal sounds. -> Green goes out. -> The upstream Master medium has been registered as the highest Master medium. 	<p>1x short</p>
--	---	-----------------

5.7.2 Create A/B structure

After holding up the Master A, the component receives the following temporary permission:



- Grant the Master B held up the permission to assign access permissions to user media.

After holding up the Master A again, the temporary permission for the component is revoked.

Prerequisites

- The Master A held up is the highest medium of the component.
See section "Define highest Master medium"

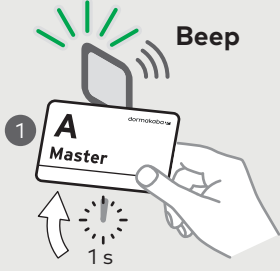
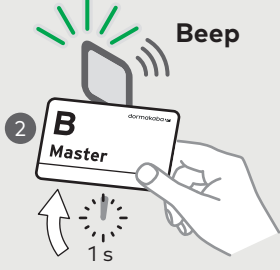
Procedure

		
	<p>Hold Master A up to the antenna for approx. 1 second.</p> <ul style="list-style-type: none"> -> Glows green. -> 1 short signal sounds. -> Green goes out. 	1x short
	<p>If no medium is held up for 20 seconds, the process is automatically terminated:</p> <ul style="list-style-type: none"> -> The changes have been applied and 1 long signal sounds. 	
	<p>Hold Master B up to the antenna for approx. 1 second.</p> <ul style="list-style-type: none"> -> Glows green. -> 1 short signal sounds. -> Green goes out. -> Master B has the permission to assign access permissions to user media. -> The A/B structure has been created. 	1x short
	<p>If needed, hold up other Master Bs.</p>	
	<p>Hold Master A up to the antenna for approx. 1 second.</p> <ul style="list-style-type: none"> -> Glows green. -> 1 long signal sounds. -> Green goes out. 	1x long

5.7.3 Grant access permissions

After holding up the Master B, the component receives the following temporary permission:



- Grant access permissions to the user medium held up (enter it on the whitelist).

After holding up the Master B again, the temporary permission for the component is revoked.

Prerequisites

- A/B structure or
- B structure is present

Procedure

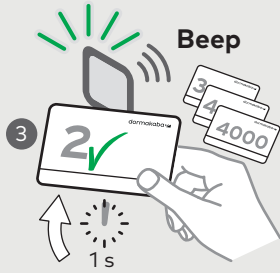
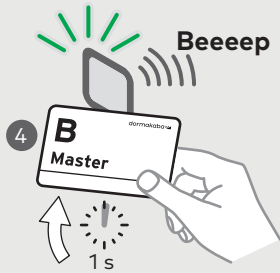
		🔊
	<p>Hold Master B up to the antenna for approx. 1 second.</p> <p>-> Glows green. -> 1 short signal sounds. -> Green goes out.</p>	1x short
	<p>If no medium is held up for 20 seconds, the process is automatically terminated:</p> <p>-> The changes have been applied and 1 long signal sounds.</p>	
	<p>Hold user medium up to the antenna for approx. 1 second.</p> <p>-> Glows green. -> 1 short signal sounds. -> Green goes out. -> The user medium has been added to the whitelist. The user medium has access to the component.</p>	1x short
	<p>If needed, add other user media to the whitelist:</p> <p>Repeat step 2.</p>	1x short
	<p>Hold Master B up to the antenna for approx. 1 second.</p> <p>-> Glows green. -> 1 long signal sounds. -> Green goes out. -> The changes have been applied.</p>	1x long
	<p>If needed, grant access permissions with another Master B.</p>	

5.7.4 Revoke individual access permissions

After holding up the Master B, the component receives the following temporary permission:





- Revoke access permissions from the user medium held up (remove it from the whitelist).

After holding up the Master B again, the temporary permission for the component is revoked.

Prerequisites

- User medium with access permission.
- A/B structure or
- B structure is present

Procedure

		
	<p>Hold Master B up to the antenna for approx. 1 second.</p> <p>-> Glows green. -> 1 short signal sounds. -> Green goes out.</p>	1x short
	<p>If no medium is held up for 20 seconds, the process is automatically terminated:</p> <p>-> The changes have been applied and 1 long signal sounds.</p>	
	<p>Hold user medium up to the antenna for approx. 3 seconds.</p> <p>-> Glows green. -> 2 short signals sound. -> Green goes out. -> The user medium has been removed from the whitelist. The user medium does not have access to the component.</p> <p>If needed, hold up other user media.</p>	2x short
	<p>Hold Master B up to the antenna for approx. 1 second.</p> <p>-> Glows green. -> 1 long signal sounds. -> Green goes out. -> The changes have been applied.</p>	1x long

5.7.5 Delete Master Bs from the component

After holding up the Master A, the component receives the following temporary permissions:



- Revoke all access permissions granted by the Master B held up (remove from the whitelist.)
- Revoke the permission to grant access permission from the Master B held up.

After holding up the Master A again, the temporary permissions for the component are revoked.

Prerequisites

- The Master B receives its permission through the Master A
- A/B structure is in place

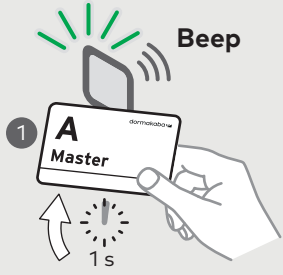
Procedure

		🔊
	<p>Hold Master A up to the antenna for approx. 1 second.</p> <p>-> Glows green. -> 1 short signal sounds. -> Green goes out.</p>	1x short
	<p>If no medium is held up for 20 seconds, the process is automatically terminated:</p> <p>-> The changes have been applied and 1 long signal sounds.</p>	
	<p>Hold up Master B to the antenna (approx. 10 seconds) until 2 short signals sound.</p> <p>-> Green glows as long as Master B is held up.</p> <p>If needed, hold up other Master Bs.</p>	2x short
	<p>Hold Master A up to the antenna for approx. 1 second.</p> <p>-> Glows green. -> 1 long signal sounds. -> Green goes out. -> The changes have been applied.</p>	1x long

5.7.6 Revoke all access permission assigned by Master B

After holding up the Master B, the component receives the following temporary right:

- Cancel all access authorizations granted by the Master B (remove from the whitelist.)

Note: The Master B has the right to grant access authorizations.

Procedure



NOTICE

Data loss

If the Master B is held for longer than 10 seconds, the INI reset is initiated. The INI reset deletes all the settings and data saved in the component.

	<p>Hold Master B up to the antenna for approx. 10 seconds.</p> <ul style="list-style-type: none"> -> Glows green. -> 1 long and 2 short signals sound (firmware version 42xx or higher). -> (Before firmware version 42xx: 2 short signals sound.) -> Green goes out. -> All access rights assigned by the Master B have been cancelled. 	<p style="text-align: right;">🔊</p> <p>Firmware version 42xx or higher:</p> <p style="text-align: center;">1 time long 1 time briefly</p> <hr/> <p>Before firmware version 42xx:</p> <p style="text-align: center;">2 times briefly</p>
--	---	---

5.7.7 INI reset with Master media

See section "Service" > "INI reset with Master media"

5.8 Initialising the device for Mobile Access

Prerequisites

- | | |
|-----------------|---|
| General | <ul style="list-style-type: none"> • The access control system is set up by dormakaba for Legic Connect |
| System software | <ul style="list-style-type: none"> • The criteria listed in the "System requirements" section have been met. • A connection to Legic Connect has been established. • The device is configured in the system software for Mobile Access. • The configuration has been transmitted to the programmer. |
| Device | <ul style="list-style-type: none"> • The device is installed and ready for operation. • The media technology has been defined, see section "Define media technology" • The configuration has been transmitted from the programmer to the device. |
| Smartphone | <ul style="list-style-type: none"> • The VCP Installer is installed and registered with the telephone number with Legic Connect. The registration code received via SMS is entered. • Access to the Internet is possible (WLAN or mobile data). • The password for the VCP file is known. |

Procedure

Transfer the Bluetooth/NFC key to the device

- Hold the master medium up to the antenna for approx. 1 second.
- Start VCP Installer on the smartphone.
- Select the VCP file.
 - If the desired VCP file is not present, select "Update". The smartphone will then download the VCP file .
- Select 'Send'.
- Input the password for the VCP file.



- Hold the smartphone in front of the reader.

Signal/display		
	Device/antenna	Smartphone
During data transmission:	<ul style="list-style-type: none"> • Green glows. 	
After successful initialisation:	<ul style="list-style-type: none"> • Three signals are sounded. 	<ul style="list-style-type: none"> • Green • Serial number of the device
The device is initialised.		
After unsuccessful initialisation:	<ul style="list-style-type: none"> • 1 brief acoustic signal sounds. • Red glows briefly. • 1 long acoustic signal sounds. • Red glows briefly. • 1 brief acoustic signal sounds. 	<ul style="list-style-type: none"> • Red

5.9 Set Bluetooth signal strength



Only change the settings from the default values if this is absolutely necessary.

- Devices without a wireless connection:
In the parent system, set the Bluetooth signal strengths and transmit them to the device using the programmer.
- Devices with a wireless connection:
In the parent system, set the Bluetooth signal strength and transfer it to the device via the wireless gateway.

Also see the Mobile Access planning guidelines

5.10 Initializing the device for evolo smart

The evolo smart app guides the user through the procedure for initializing the components.

6 Operation

This section describes operation of the product.

6.1 Operating the digital cylinder

The digital cylinders are operated with user media. The lock can only be operated if the user media has an access authorisation. Unauthorised user media are rejected.

6.2 Opening with user media



Before being used for the first time, access authorisations for the relevant system software must be transmitted to the User media.

1. Hold the authorized user medium with the valid access authorization in front of the thumbturn knob.

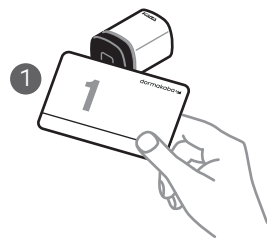

2. Access authorization will be signalled by an acoustic signal¹ and a visual display¹.



The Digital cylinder's opening time is limited; after this opening time has elapsed, the Digital cylinder closes automatically. Upon delivery, the opening time is approx. 6 s, but this can be adjusted using the 1460 programmer or the system software.

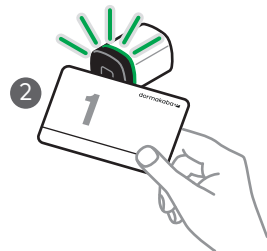

3. Activate the lock by turning the thumbturn.

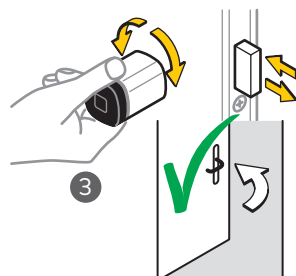

⇒ The door can be opened.

If there is an attempt to gain access using unauthorized user media, the acoustic ¹ signal will briefly sound four times and the red¹ light will briefly flash four times.

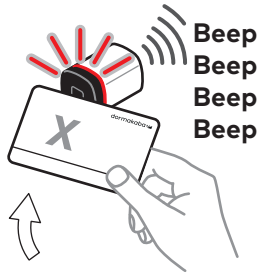

Legend:

- ¹ If both functions have been activated using the 1460 programmer or the system software.

6.3 Opening via smartphone

For Mobile Access applications

Requirements

- The device has been initialized.
- The access rights were transferred to the smartphone by the parent system.

Procedure

- Start up the app on the smartphone.



- Tap the key.



Countdown starts for time as defined in the app.

- Hold the smartphone in front of the device.

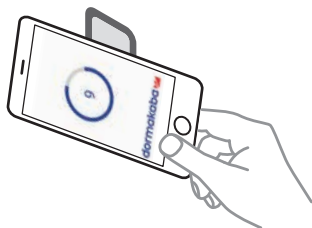

Signalling

The smartphone shows the access authorization.

Device with signalling

The device signals the access authorization acoustically¹ and visually¹.



Signal for unauthorized user medium: 4x brief acoustic¹ and 4x brief red¹

¹ As long as the function(s) were activated with the programmer or the system software.

Note: The opening time is limited. After the opening time expires, the device closes automatically. The opening time upon delivery is approx. 6 seconds. The opening time can be changed with Programmer 1460 or in the parent system.

- Activate the lock by pressing the lever handle.

7 Maintenance

This section describes product maintenance.

7.1 Maintenance table



NOTICE

Opening the mechatronic unit.

Opening the mechatronic unit releases the manufacturer from any liability under the guarantee.

Maintenance interval

Components	Measures	Interval
Digital cylinder all variants	Function check as specified in the instructions for the components.	12 months
	Replacing the batteries in pure RFID operation.	≤ 24 months
	Replacing the batteries during wireless or Mobile Access operation.	12 months
Clock (components)	Check and set time with the system software (the time is updated with every programming procedure). Not required for wireless connection.	12 months
Firmware update	For functional modifications.	as required

The component's mechanism and/or electronics do not require any maintenance.

7.2 Maintenance of escape doors



⚠ WARNING

Risk of personal injury or death.

The service life of the digital anti-panic cylinder is limited by the spring mechanism.

Consequently, they must be replaced by the manufacturer after 10 years.



⚠ WARNING

Risk of personal injury or death.

For emergency exit locks in accordance with EN 179 and panic door locks in accordance with EN 1125, comply with the lock manufacturer's maintenance advice.

Function check on anti-panic digital cylinder

As part of maintenance on a panic lock, also carry out a function check on the anti-panic digital cylinder. (See Chapter Function check on anti-panic digital cylinder [▶ 4.3.3].)

7.3 Cleaning



Only disinfection agents that are explicitly formulated for cleaning delicate metal surfaces and plastics may be used. The use of unsuitable cleaning agents or methods can damage the components' surface.

1. Use a soft, damp cloth to clean the surface.

8 Service



NOTICE

Do not oil the Digital cylinder!

8.1 Replacing the battery



Whilst the battery is being changed, all the data (access authorisations, configurations and traceback) is retained in the battery-independent memory. The clock settings are lost after 45 seconds.

Requirements:

- New battery available
- Tool – multitool available



Do not use rechargeable batteries or accumulators.



NOTICE

Danger of damage to electronic components from electrostatic discharge.

Damage may occur if electronic printed circuit boards and components are handled incorrectly, which leads to complete breakdown or malfunctions of the device.

- Adhere to and use the general ESD protective measures when handling electronic components.

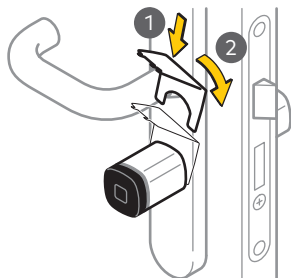

1. Position the multitool on the inner side of the outer knob.
2. Turn the multitool to the left and unlock the outer knob.

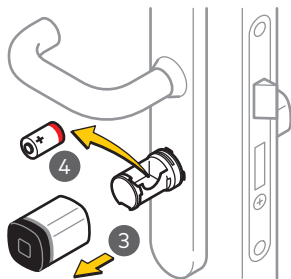

3. Remove the outer knob.
4. Remove the spent battery.

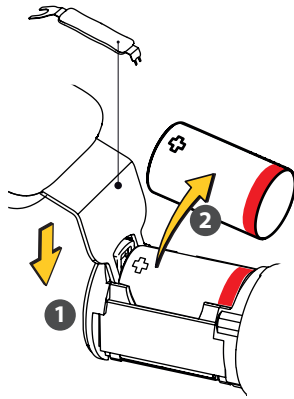

Note:

If necessary, remove it using the multitool.

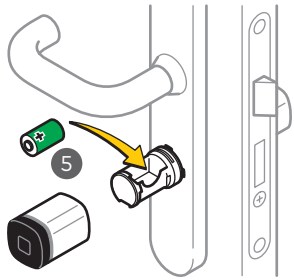

5.

Note:

Make sure you check the polarity of the battery!
Insert the new battery.

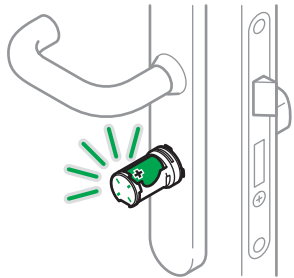

Note:

After inserting the battery, the LEDs will briefly flash green once.
The component is now ready again.

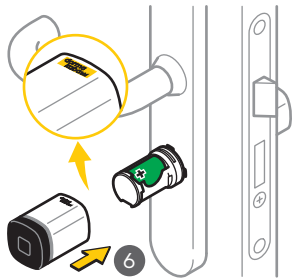

6.

Push the outer knob over the knob module.

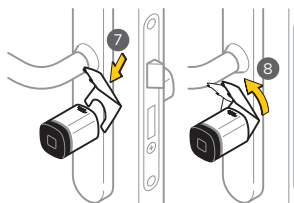

7.

Position the multitool on the outer knob.

8.

Turn the multitool to the left and lock it.
The outer knob and the cylinder are now firmly connected.

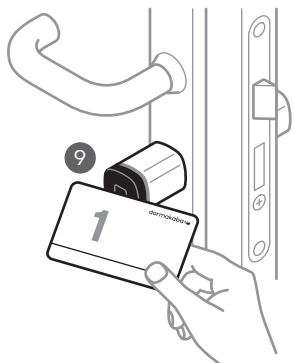

9.

Check that the Digital cylinder is functioning correctly.

10.

Check the time [▶ 8.3](#) and adjust if required.

8.2 Disassembling the inner door knob

8.2.1 Thumbturn «click»

✓ Tool: Multitool present

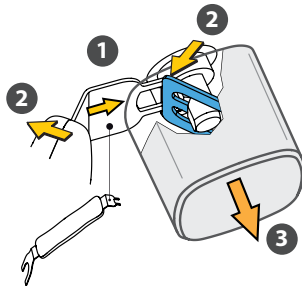

1. Insert the multitool with the narrow claw between the dial and the fitting.
2. Press multitool against the fitting.
 - ⇒ The action spring releases.
3. Pull off the dial.

8.2.2 Thumbturn «small»

✓ Hexagon socket wrench, 2 mm hex available

1. Loosen the thumbturn screw using the hexagon socket wrench.

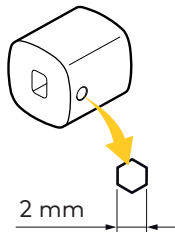

2. Remove the thumbturn.

8.3 Configuration and traceback



Correctly set values for date and time ensure timely management with the components.

Components connected to the system software via the wireless function are updated via the gateway (e.g. time, configurations.) Traceback can be read out with the system software.

In purely standalone operation, the configurations are transferred with the Programmer or can be modified with it (e.g. setting time.)

Traceback can be read out with a Programmer and transferred to the system software for evaluation.

Additional steps are described in the documents *Programmer 1460* and *Programmer 1364*.

8.4 Reset (INI reset)

INI reset of e-module

An INI reset can be used to restore the factory settings for the components.



NOTICE

Loss of data

With an INI reset, all previously saved settings and data on the E-module are deleted.



NOTICE

Before components are sent back for servicing, always carry out a reset on the components.



8.4.1 INI reset with Master media

Consequences of an INI reset

- All parameter settings and data are deleted and returned to their original values (factory settings).
- The access point is blocked during the INI reset.
- All access permissions, Master media and traceback are deleted.
- The passage is locked after the INI reset.

8.4.1.1 Whitelist

In Master B structure

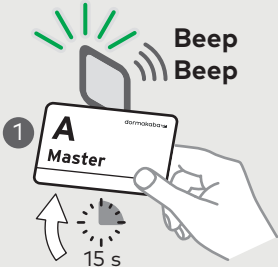

INI reset with Master B		
	Hold Master B up to the antenna for approx. 15 seconds . -> Glows green. -> Successive signals sound. -> After 15 seconds the INI reset is carried out. -> Green goes out.	After 10 seconds: 1x long, 1x short, after 15 seconds, 2x short

In Master A/B structure

INI reset with Master A		
	Hold Master A up to the antenna for approx. 15 seconds . -> Glows green. -> Successive signals sound. -> After 15 seconds the INI reset is carried out. -> Green goes out.	After 10 seconds: 1x long, 1x short, after 15 seconds, 2x short

8.4.1.2 Cardlink

With Master B

INI reset with Master B		
	<p>Hold Master B up to the antenna for approx. 15 seconds.</p> <ul style="list-style-type: none"> -> Glows green. -> After 15 seconds the INI reset is carried out. -> 2 short signals sound. -> Green goes out. 	2x short

With Master A

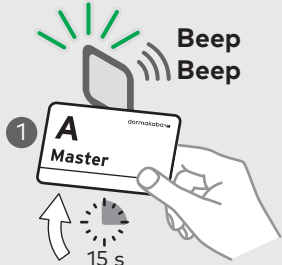
INI reset with Master A		
	<p>Hold Master A up to the antenna for approx. 15 seconds.</p> <ul style="list-style-type: none"> -> Glows green. -> After 15 seconds the INI reset is carried out. -> 2 short signals sound. -> Green goes out. 	2x short

8.4.2 Reset using programmer 1460

1. Hold valid master medium in front of the component's antenna.
 2. Open **Settings** menu.
 3. Select **Actuator**.
 4. Select **INI reset**.
 5. Select **Yes**.
- ⇒ Successful INI reset is confirmed using an acoustic signal.

Additional steps are described in the *programmer 1460* document.

8.4.3 Reset using tweezers



NOTICE

Danger of damage to electronic components from electrostatic discharge.

Damage may occur if electronic printed circuit boards and components are handled incorrectly, which leads to complete breakdown or malfunctions of the device.

- Adhere to and use the general ESD protective measures when handling electronic components.

INI reset with tweezers and valid master media

The components have INI reset contacts on the e-module.

To perform an INI reset, short-circuit these contacts with electrically conductive tweezers.

Before short-circuiting, present a valid master medium or user medium.

1. Disassemble Knob.
 2. Localise both contacts on the e-module. (See chapter "Contacts for INI reset")
 3. Using the tweezers, short-circuit the INI reset contacts for approx. 3 s.
- ⇒ Successful INI reset is confirmed using two acoustic signals.

8.4.4 Contacts for INI reset

For carrying out INI reset with tweezers, the following contacts are used:

MRD e-module and wireless variants

The INI reset contacts are on the round PCB on the front.

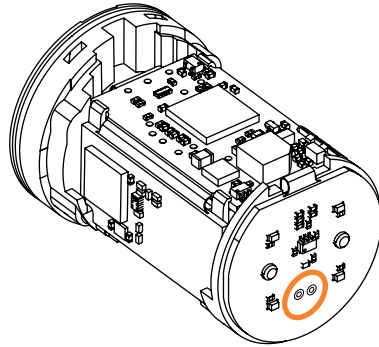

The PCBs in these modules are blue.

8.5 Emergency power supply

If all the alarm signals are ignored until the batteries are completely flat, doors can no longer be opened from the outside with the digital cylinder. In this case, insert a new battery.



The digital cylinder does not require an emergency power supply using the 1460 programmer.

8.6 Connect programmer.

The contacts for connecting the programmer are on the edge right next to the above PCB.

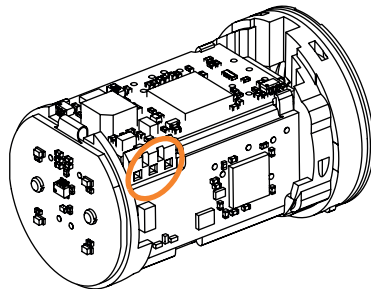



Connect the Digital cylinder and the programmer using the programmer cable and the programmer adapter.

9 Troubleshooting

This chapter provides important information for analysing errors and troubleshooting.

9.1 Error analysis

Symptoms			Possible causes	Measures
The use of a master or user medium is confirmed via various acoustic and/or visual signals by the components	1 x very short	9 x flashes red ⁵	Battery 'Low' (V4 FW 42.XX)	Replace the batteries
The use of a master or user medium is confirmed via various acoustic and/or visual signals by the components	9 x very short ⁵	— ²	Battery 'Low' (V4 FW 42.XX) ²	Replace the batteries
The use of a master or user medium is confirmed via various acoustic and/or visual signals by the components	2 x long	after 4 s 1 x short green ⁵	Battery 'Low' (V3 FW 31.XX/32.XX) ²	Replace the batteries
Door does not open: authorization by an authorized user medium is confirmed via acoustic signals	1 x very long	—	Alarm — Battery 'Empty'	Replace the batteries
Door does not open: authorization by an authorized user medium is confirmed via acoustic and visual signals	8 x short	8 x short red	Self-test function could not be completed. ³	Check or replace the coupling unit
Door does not open: authorization by an authorized user medium is confirmed via acoustic and visual signals	4 x short	4 x short red	Medium not programmed Outside the time frame	Program the medium Check time profiles
Door does not open: authorization by an authorized user medium is confirmed via acoustic and visual signals	1 x long 1 x short 1 x long	1 x short green	Internal clock in component has failed	Check programming and clock time
User medium cannot be programmed	—	—	4,000 media or groups already programmed in the e-module Defective medium Not the correct technology	Contact customer service
Master medium cannot be programmed	1 x short	1 x red	E-module already programmed	Execute INI reset
Master medium is not detected	—	—	No power supply	Check batteries or power supply
Incorrect e-module on Digital cylinder	—	3 x red flash	E-module knob and MC insert are not compatible (V4 FW 42.XX)	Check compatibility
Other errors	—	1 x short red	Unintentional re-start	—

Symptoms			Possible causes	Measures
		1 x short green 1 x short red		
Other errors	1 x short 1 x long 1 x short	— ²	Unintentional re-start	—

Key:

- ² Components without visual display
- ³ Function only for c-lever, mechatronic cylinder and digital cylinder
- ⁵ The actuator subsequently opens

9.2 Error analysis for battery life

Symptoms	Possible causes	Measures
Battery life deviates significantly from expectations	More accesses than anticipated	Read traceback and check
	Low temperatures	Insert new, recommended battery Insert EXT variant batteries for extremely low temperatures
	Firmware version not up to date	Carry out update to current firmware version
	Programming/configuration with non-used functions	Adjust programming/configuration
	Battery was not new	Insert new, recommended battery
	Batteries that look identical can contain different amounts of energy	Insert new, recommended battery
	E-module knob with battery installed was stored separately from Digital cylinder	Insert new battery Store e-module knob without battery
	Defective electronics	Contact support
	Activation of Digital cylinder without RFID medium, e.g. by holding your hand in front of it	Inform user
	Many unauthorized access attempts (unauthorized access requires more energy than authorized access)	Clarify causes
	Coupling monitoring often active	Carry out update to current firmware version

10 Appendix

This chapter provides additional information about the battery operation.

10.1 Summary of various factors influencing the battery operation

The Digital cylinder operates with a 3 V CR2 lithium battery.

The battery life is affected by the following factors:

- Number of accesses and actions (frequency of use)
- Programming/configuration of components
- The interval time set for Object in Field (OiF)
- Battery type
- Battery manufacturer
- Ambient temperature
- Firmware version

10.2 Recommendations for battery operation

- Always use the up-to-date firmware version for the products.
- Always only activate the functions actually required.
- Record the battery replacement date in a maintenance plan.
If the battery life does not meet expectations, determine the cause in accordance with Chapter [\[▶ 9.2\]](#).
- When the battery is 'low', replace immediately.
- Explain to user the 'low' battery warning signal and urge them to report the 'low' battery warning to the person responsible immediately.
- Keep a stock of currently recommended batteries:
 - Panasonic CR2 Industrial (made in Japan or Indonesia)
 - Panasonic CR2 PHOTO Power (made in Japan or Indonesia)
 - Duracell Ultra CR2 (made in Japan or Indonesia)